

COBRA

MODEL: BV26C (EBV260A)

PETROL BLOWER VACUUM

CE   EMC













OPERATORS MANUAL



IMPORTANT!

IT IS ESSENTIAL THAT YOU READ THE INSTRUCTIONS IN THIS MANUAL
BEFORE OPERATING THIS MACHINE.

KEY TO SYMBOLS

	WARNING: This blower can be dangerous! Careless or improper use can cause serious or even fatal injury.		Use unleaded or quality leaded petrol and two stroke oil.
	Read and understand the instruction manual before using the blower.		WARNING: The blower may throw objects at high velocity that can ricochet and hit the operator. This may cause serious eye damage.
	Approved protective goggles or visor, ear protection, and face mask in dusty environments must be worn.		WARNING: The muffler is very hot during and after use. Do not touch the muffler, muffler guard, or surrounding surfaces, or allow combustible material such as dry grass or fuel to do so.
	Always wear approved, protective gloves.		The blower operator must make sure that no bystanders or animals come nearer than 15 meters. Whenever several operators are working in the same work area, they should maintain a safe distance of at least 15 meters from one another.
	WARNING: Be sure the bottom cover is secured or the vacuum tube is properly installed. Avoid the impeller blade with your hand or any foreign object.		
	Instructions on how to open vacuum inlet cover.		76 NOISE dBA Sound pressure level at 7,5 meters
			108dB LWA Sound power level

SAFETY RULES

⚠ WARNING: Failure to follow all Safety Rules and Precautions can result in serious injury.

KNOW YOUR UNIT

- Read your instruction manual carefully until you completely understand and can follow all warnings and safety rules before operating the unit.
- Restrict unit to users who understand and will follow all warnings and safety rules in this manual.

⚠ WARNING: Inspect area before starting unit. Remove all debris and hard objects such as rocks, glass, wire, etc. that can ricochet, be thrown, or otherwise cause injury or damage during operation.

Use your unit as a blower for:

- Sweeping debris or grass clippings from driveways, sidewalks, patios, etc.
- Blowing grass clippings, straw, or leaves into piles, around joints, or between bricks.

Use your unit as a vacuum for:

- Picking up dry material such as leaves, grass, small twigs, and bits of paper.

- For best results during vacuum use, operate your unit at high speed.
- Move slowly back and forth over the material as you vacuum. Avoid forcing the unit into a pile of debris as this can clog the unit.
- Keep the vacuum tube about an inch above the ground for best results.

PLAN AHEAD

⚠ WARNING: This machine produces an electromagnetic field during operation. Under some circumstances, this field may interfere with active or passive medical implants. To reduce the risk of serious or fatal injury, we recommend persons with medical implants to consult their physician and the medical implant manufacturer before operating this machine.

- Always wear eye and ear protection when operating, servicing, or performing maintenance on unit. Wearing eye protection will help to prevent rocks or debris from being blown or ricocheting into eyes and face which can result in blindness and/or serious injury. Eye protection should be marked Z87.
- Always wear foot protection. Do not go barefoot or wear sandals.

- Always wear respirator or face mask when working with unit in dusty environments.
- Secure hair above shoulder length. Secure or remove jewelry, loose clothing, or clothing with loosely hanging straps, ties, tassels, etc. They can be caught in moving parts.
- Do not operate unit when you are tired, ill, upset, or if you are under the influence of alcohol, drugs, or medication.
- Keep children, bystanders, and animals away from work area a minimum of 15 meters when starting or operating unit. Do not point blower nozzle in the direction of people or pets.

HANDLE FUEL WITH CAUTION

- Eliminate all sources of sparks or flame (including smoking, open flames, or work that can cause sparks) in the areas where fuel is mixed, poured, or stored.
- Mix and pour fuel in an outdoor area; store fuel in a cool, dry, well ventilated place; use an approved, marked container for all fuel purposes.
- Do not smoke while handling fuel or while operating the unit.
- Make sure the unit is properly assembled and in good operating condition.
- Do not fill fuel tank while engine is hot or running.
- Avoid spilling fuel or oil. Wipe up fuel spills before starting engine.
- Move at least 3 meters away from fuel and fueling site before starting engine.
- Always store petrol in a container approved for flammable liquids.

OPERATE YOUR UNIT SAFELY

⚠ WARNING: Stop the engine before opening the vacuum inlet door. The engine must be stopped and the impeller blades no longer turning to avoid serious injury from the rotating blades.

- This garden blower/vacuum is only designed for blowing away or removal of leaves and other debris on the ground.
- Inspect unit before each use for worn, loose, missing, or damaged parts. Do not use until unit is in proper working order.
- Keep outside surfaces free of oil and fuel.
- Never start or run engine inside a closed room or building. Breathing exhaust fumes can kill.
- Mufflers fitted with catalytic converters get very hot during use and remain so for some time after stopping. This also applies at idle speed. Contact can result in burns to the skin. Remember the risk of fire!
- To avoid static electricity shock, do not wear rubber gloves or any other insulated gloves while operating unit.
- Do not set unit on any surface except a clean, hard area while engine is running. Debris such as gravel, sand, dust, grass, etc. could be picked up by the air intake and thrown out through discharge opening, damaging unit, property, or causing serious injury to bystanders or operator.
- Avoid dangerous environments. Do not use in unventilated areas or where explosive vapors

or carbon monoxide build up could be present.

- Do not overreach or use from unstable surfaces such as ladders, trees, steep slopes, rooftops, etc. Keep firm footing and balance at all times.
- Never place objects inside the blower tubes; always direct the blowing debris away from people, animals, glass, and solid objects such as trees, automobiles, walls, etc. The force of air can cause rocks, dirt, or sticks to be thrown or to ricochet which can hurt people or animals, break glass, or cause other damage.
- Never run unit without the proper equipment attached. When using your unit as a blower, always install blower tubes. When using your unit as a vacuum, always install vacuum tubes and vacuum bag assembly. Make sure vacuum bag assembly is completely zipped.
- Check air intake opening, blower tubes, vacuum tubes, and elbow tube frequently, always with engine stopped and spark plug disconnected. Keep vents and discharge tubes free of debris which can accumulate and restrict proper air flow.
- Never place any object in the air intake opening as this could restrict proper air flow and cause damage to the unit.
- Never use for spreading chemicals, fertilizers, or other substances which may contain toxic materials.
- To avoid spreading fire, do not use near leaf or brush fires, fireplaces, barbecue pits, ashtrays, etc.
- Use only for jobs explained in this manual.

MAINTAIN YOUR UNIT PROPERLY

- Have all maintenance other than the recommended procedures described in the instruction manual performed by an authorized service dealer.
- Disconnect spark plug before performing maintenance except for carburetor adjustments.
- Use only recommended Qualified replacement parts; use of any other parts may void your warranty and cause damage to your unit.
- Empty fuel tank before storing the unit. Use up fuel left in carburetor by starting engine and letting it run until it stops.
- Do not use any accessory or attachment other than those recommended by manufacturer for use with your unit.
- Do not store the unit or fuel in a closed area where fuel vapors can reach sparks or an open flame from hot water heaters, electric motors or switches, furnaces, etc.
- Store in a dry area out of reach of children.
- Secure the machine during transport.

SAFETY NOTICE: Exposure to vibrations through prolonged use of gasoline powered hand tools could cause blood vessel or nerve damage in the fingers, hands, and joints of people prone to circulation disorders or abnormal swelling. Prolonged use in cold weather has been linked to blood vessel damage in otherwise healthy people. If symptoms occur such as numbness, pain, loss of strength, change in skin color or texture, or loss of feeling in the fingers,



EC-DECLARATION OF CONFORMITY

EC Declaration of Conformity	
We herewith declare,	Cobra Garden Machinery Henton & Chattell Ltd, London Road, Nottingham NG2 3HW United Kingdom
that the following machine complies with the appropriate basic safety and health requirements of the EC Directive based on its design and type, as brought into circulation by us.	
In case of alteration of the machine, not agreed upon by us, this declaration will lose its validity	
Machine Description:	Blower Vacuum
Machine Type:	BV26C (EBV26A)
Displacement	25.4 cm ³
Measured sound power level:	104dB(A)
Guaranteed sound power level:	108dB(A)
	Notified Body for EC Directive 2000/14/EC:0036 TÜV Rheinland LGA Products GmbH, Tillystr. 2 90431 Nürnberg Deutschland
Applicable EC Directives	EC Machinery Directive:2006/42/EC EC Directive of Electromagnetic Compatibility:2004/108/EC EC Directive of noise emission: 2000/14/EC
Applicable Harmonized Standards	EN836 EN ISO 14982
Authorized Signature/Date	 Peter J. Chaloner 18-09-2014
Title of Signatory	Managing Director
Name and address of the person authorised to compile the technical file	Cobra Garden Machinery Henton & Chattell Ltd, London Road, Nottingham NG2 3HW United Kingdom

EBV260A PART LIST

SER.NO	PART NAME	PART NO.	QTY.	SER.NO	PART NAME	PART NO.	QTY.	SER.NO	PART NAME	PART NO.	QTY.	SER.NO	PART NAME	PART NO.	QTY.	SER.NO	PART NAME	PART NO.	QTY.
1	SCREW M4x30	GB/T9074.4	1	24	PISTON RING	RE34F-6-5	2	47	SCREW M5x16	RE34F-7B-7	1	70	SPRING	EBV260A-14	1				
2	AIR FILTER COVER	RE34F-7B-1	1	25	PISTON	RE34F-6-6	1	48	FUEL TANK	RE34F-7B-7	1	71	SCREW M6x30		1				
3	PLATE-FILTER COVER	RE34F-7B-2	1	26	PISTON PIN	RE34F-6-3	1	49	FUEL CAP	EBH454.1	1	72	LOCKOUT HANDLE	EBV260A-10	1				
4	SCREW ST3.3x10		2	27	PISTON PIN CIRCLET	RE34F-6-2	2	50	FUEL LINE	EBV260A-24	1	73	SWITCH	CG431-CZ-1-7	1				
5	AIR FILTER	RE34F-1-1	1	28	NEEDLE BEARING	RE34F-6-4	1	51	EYELET	GB975	1	74	WASHER	EBV260A-6	1				
6	AIR FILTER BASE	RE34F-7B-4	1	29	STOP RING	RE34F-6-1	2	52	FUEL LINE	EBV260A-23	1	75	LOCKOUT	EBV260A-11	1				
7	CARBURETOR	M71244	1	30	SCREW ST4.8x14		15	53	FILTER	RE34F-2-3	1	76	Net defence	EBV260A-32	1				
8	GASKET-CARB	RE34F-7B-3	1	31	CYLINDER COVER	EBV260A-2	1	54	HANDLE-RIGHT	EBV260A-15	1	77	IMPELLER COVER	EBV260A-13	1				
9	SCREW M5x20	GB/T9074.4	2	32	SCREW M4x16	GB/T9074.4	4	55	SCREW ST4.8x25		2	78	UPPER VACUUM TUBE	EBV260A-20	1				
10	INLET MANIFOLD	RE34F-4	1	33	STARTER	RE34F-7B-3	1	56	SPRING-TRIGGER	EBV260A-7	1	79	LOWER VACUUM TUBE	EBV260A-19	1				
11	GASKET-INLET MANIFOLD	RE34F-7B-4	1	34	STARTER HANDLE	RE34F-7B-8	1	57	TRIGGER	EBV260A-9	1	80	UPPER TUBE	EBV260A-18	1				
12	SCREW M5x50	GB/T701	2	35	STARTER PULLEY	RE34F-8.1	1	58	THROTTLE LEVER	EBV260A.2	1	81	LOWER DIAPHRAGM TUBE	EBV260A-17	1				
13	SPRING WASHER 5	GB/T93	2	36	OIL SEAL	RE34F.2	2	59	STOP WIRE	EBV260A.1	1	82	LOWER TUBE	EBV260A-16	1				
14	FLAT W WASHER 5	GB/T97.1	2	37	CRANK CASE-REAR HALF	RE34F-7B-6	1	60	VOLUTE CASE	EBV260A-4	1	83	NOZZLE	EBV260A-32	1				
15	MUFFLER	RE34F-7B-1	1	38	BALL BEARING	GB/T276	2	61	MUTE 8		1	84	CONTACTOR	EBV260A-35	1				
16	GASKET-MUFFLER	RE34F-7B-5	1	39	CRANK SHAFT COMP	RE34F-7B.2	1	62	COVER-FLY WHEEL	EBV260A-5	1	85	GANGSWITCH	EBV260A-33	1				
17	SPARK PLUG	L6	1	40	KEY	RE40F-32.3-1	1	63	SUPPORTING TUBE	EBV260A-1	1	86	SWITCH COVER	EBV260A-34	1				
18	SCREW M5x20	GB/T701	4	41	GASKET-CRANK CASE	RE34F.7-2	1	64	WASHER	EBV260A-25	1	87	RUBBER	EBV260A-40	4				
19	SPRING WASHER 5	GB/T848	4	42	SCREW M5x50	GB/T9074.4	2	65	IMPELLER	EBV260A-12	1	88	RIGHT BOX	EBV260A-41	1				
20	IGNITION HOOD/LE	RE34F-7B-5	1	43	PIN 3x10	GB/T119	4	66	COMMUNITE BOARD	EBV260A-8	1	89	LEFT BOX	EBV260A-42	1				
21	SCREW M4x20	GB/T9074.4	2	44	CRANK CASE-FRONT HALF	RE34F.7-1	1	67	ELBOW TUBE	EBV260A-21	1	90	SCREW ST4.8x25		1				
22	CYLINDER	RE34F-7A-1	1	45	VACUUM BAG	EBV260A.6	1	68	MUTE		1	91	SPRING WASHER 8		1				
23	GASKET-CYLINDER	RE34F-9	1	46	FLY WHEEL	RE34F	1	69	VOLUTE CASE	EBV260A-3	1	92	STOP WIRE	EBV260A-39	1				

hands, or joints, discontinue the use of this tool and seek medical attention. An antivibration system does not guarantee the avoidance of these problems. Users who operate power tools

on a continual and regular basis must monitor closely their physical condition and the condition of this tool.

WHAT IS WHAT?

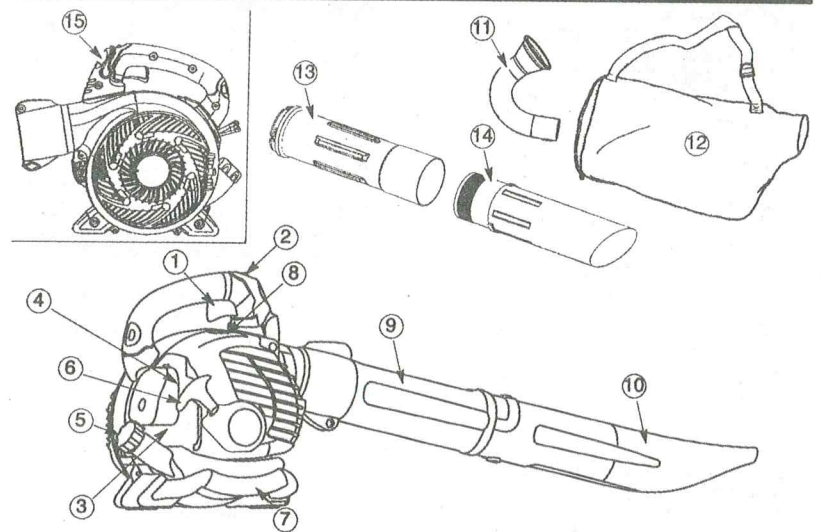

WHAT IS WHAT?

1. Throttle trigger
2. STOP switch
3. Primer button
4. Start lever
5. Fuel cap
6. Starter rope
7. Vacuum handle
8. Spark plug
9. Upper blower tube
10. Lower blower tube
11. Elbow tube
12. Vacuum bag
13. Upper vacuum tube
14. Lower vacuum tube
15. Throttle position lever
16. Instruction manual



16

ASSEMBLY

CARTON CONTENTS

Check carton contents against the following list.

- Blower
- Upper blower tube
- Lower blower tube
- High velocity nozzle
- Elbow tube
- Vacuum bag
- Upper vacuum tube
- Lower vacuum tube
- Screw for vacuum tube assembly

NOTE: It is normal for the fuel filter to rattle in the empty fuel tank.

ASSEMBLY

WARNING: Stop engine and be sure the impeller blades have stopped turning before opening the vacuum inlet door or at-

tempting to insert or remove the vacuum or blower tubes. The rotating blades can cause serious injury. Always disconnect the spark plug before performing maintenance or accessing movable parts.

WARNING: If received assembled, repeat all steps to ensure your unit is properly assembled and all fasteners are secure. Follow all safety information in the manual and on the unit.
• A standard screwdriver is required for assembly.

BLOWER ASSEMBLY

BLOWER TUBE ASSEMBLY

1. Align the rib on the upper blower tube with the groove in the blower outlet; slide the tube into place.

NOTE: The tube clamp bolt must be loose enough to allow blower tube to be inserted in blower outlet. Loosen the bolt by turning counterclockwise (do not remove nuts).

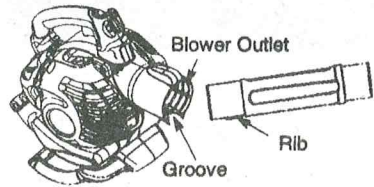

2. Secure the tube by turning the bolt clockwise.
3. Align the slots on the lower blower tube with the tabs on the upper blower tube.

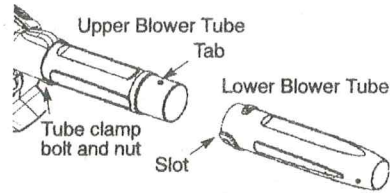

4. Slide the lower blower tube onto the upper blower tube.
5. Turn the lower blower tube clockwise until a click is felt to secure the lower blower tube to the upper blower tube.

NOTE: When the upper and lower blower tubes are assembled together properly, the arrows on both tubes will be aligned.

WARNING:

Before starting engine, the upper blower tube must be installed.

6. To remove the tubes, turn the bolt counterclockwise to loosen the tubes (do not remove nuts); remove the tubes.

HIGH-SPEED NOZZLE ASSEMBLY
When greater air speed is desired, use the high-speed nozzle.

1. Align the slots on the nozzle with the tabs on the lower blower tube.

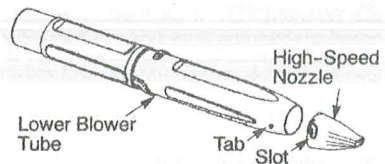

2. Slide the nozzle onto the lower blower tube.
3. Turn the nozzle clockwise until a click is felt to secure the nozzle to the lower blower tube.

VACUUM ASSEMBLY
VACUUM BAG ASSEMBLY

1. Open the zipper on the vacuum bag and insert the elbow tube.
2. Push the small end of the elbow tube through the small opening in the bag.

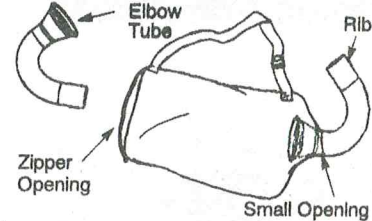

NOTE: Make sure edge of the small opening is flush against the flared area of the elbow tube, and the rib on the elbow tube is on the bottom.

3. Close the zipper on the bag. Make sure the zipper is closed completely.
4. Remove blower tubes from engine.

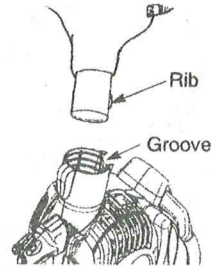

5. Insert the elbow tube into the blower outlet. Make sure elbow tube rib is aligned with the blower outlet groove.
6. Turn knob clockwise to secure elbow tube.

VACUUM TUBE ASSEMBLY

WARNING: Stop engine and be sure the impeller blades have stopped turning before opening the vacuum inlet door or attempting to insert or remove the vacuum or blower tubes. The rotating blades can cause serious injury.

1. Insert the tip of a screwdriver into the latch area of the vacuum inlet.

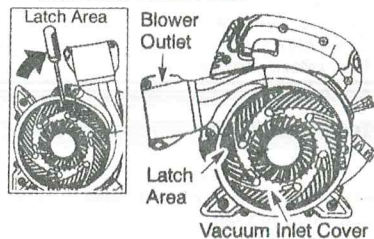

2. Gently tilt the handle of the screwdriver toward the front of the unit to release the latch while pulling up on the vacuum inlet cover with your other hand.

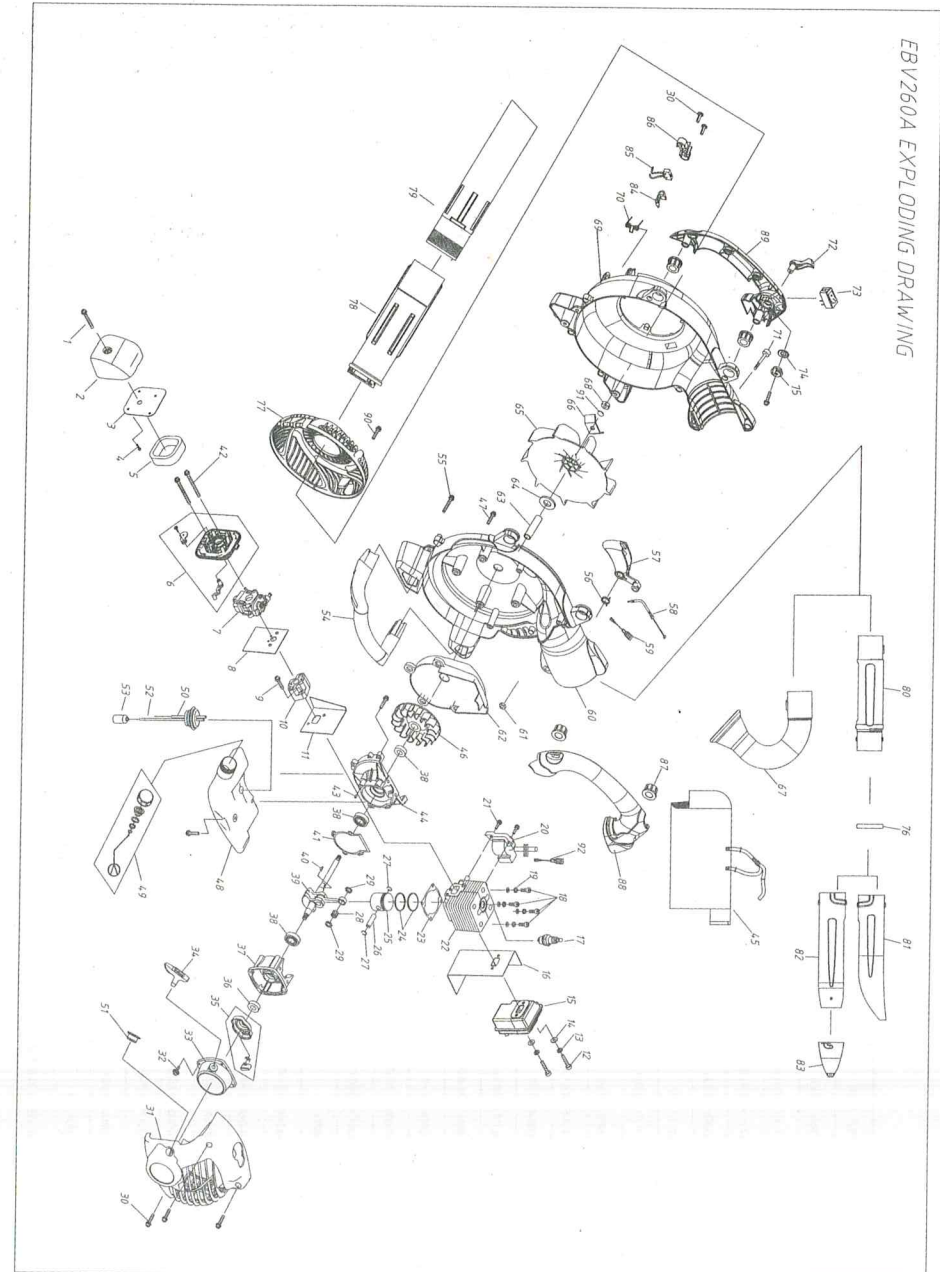

EBV260A EXPLODING DRAWING

EB260A PART LIST

SER.NO	PART NAME	PART NO.	QTY.	SER.NO	PART NAME	PART NO.	QTY.	SER.NO	PART NAME	PART NO.	QTY.	SER.NO	PART NAME	PART NO.	QTY.
1	SCREW M4x30	GB/19074.4	1	24	PISTON RING	1E34F-6-5	2	47	SCREW M5x16	1E34F-7B-7	1	70	SPRING	EBV260A-14	1
2	AIR FILTER COVER	1E34F-7B-1	1	25	PISTON	1E34F-6-6	1	48	FUEL TANK	1E34F-7B-7	1	71	SCREW M6x30	EBV260A-10	1
3	PLATE-AIR FILTER COVER	1E34F-7B-2	1	26	PISTON PIN	1E34F-6-3	1	49	FUEL CAP	EB4-15-1	1	72	LOCKOUT HANDLE	EBV260A-10	1
4	SCREW ST3x30	1E34F-7B-3	2	27	PISTON PIN CIRCLET	1E34F-6-2	2	50	FUEL LINE	EBV260A-24	1	73	SWITCH	CG43T-CZ-L-7	1
5	AIR FILTER	1E34F-1-1	1	28	NEEDLE BEARING	1E34F-6-4	1	51	eyelet	GB975	1	74	WASHER	EBV260A-6	1
6	AIR FILTER BASE	1E34F-7B-4	1	29	STOP RING	1E34F-6-1	2	52	FUEL LINE	EBV260A-23	1	75	LOCKOUT	EBV260A-11	1
7	CARBURETOR	WY244	1	30	SCREW ST4.8x14	EBV260A-2	19	53	FILTER	1E34F-9-2-3	1	76	Net defence	EBV260A-32	1
8	GASKET-CARB	1E34F-7B-3	1	31	CYLINDER COVER	GB/19074.4	4	54	HANDLE-RIGHT	EBV260A-15	1	77	IMPELLER COVER	EBV260A-13	1
9	SCREW M5x20	GB/19074.4	2	32	SCREW M4x16	1E34F-7B-3	1	55	SCREW ST4.8x25	EBV260A-7	1	78	RIGHT BOX	EBV260A-41	1
10	INLET MANIFOLD	1E34F-4	1	33	STARTER	1E34F-7B-8	1	56	SPRING-TRIGGER	EBV260A-9	1	79	LEFT BOX	EBV260A-42	1
11	GASKET-INLET MANIFOLD	1E34F-7B-4	1	34	STARTER HANDLE	1E34F-81	1	57	TRIGGER	EBV260A-9	1	80	UPPER TUBE	EBV260A-18	1
12	SCREW M5x50	GB/770.1	2	35	STARTER PULLEY	1E34F-81	1	58	THROTTLE LEVER	EBV260A.2	1	81	LOWER DUCKBILL TUBE	EBV260A-17	1
13	SPRING WASHER 5	GB/793	2	36	OIL SEAL	1E34F-2	2	59	STOP WIRE	EBV260A.1	1	82	LOWER TUBE	EBV260A-16	1
14	FLAT WASHER 5	GB/1917.1	2	37	CRANK CASE-REAR HALF	1E34F-7B-6	1	60	VOLUTE CASE	EBV260A-4	1	83	NOZZLE	EBV260A-22	1
15	MUFFLER	1E34F-7B-1	1	38	BALL BEARING	GB/1276	2	61	NUTE	EBV260A-4	1	84	SPRING WASHER 8		1
16	GASKET-MUFFLER	1E34F-7B-5	1	39	CRANK SHAFT COMP.	1E34F-7B.2	1	62	COVER-FLY WHEEL	EBV260A-5	1				
17	SPARK PLUG L6		1	40	KEY	1E40F-32.3-1	1	63	SUPPORTING TUBE	EBV260A-1	1				
18	SCREW M5x20	GB/770.1	4	41	GASKET-CRANK CASE	1E34F-7-2	1	64	WASHER	EBV260A-25	1				
19	SPRING WASHER 5	GB/1948	4	42	SCREW M5x50	GB/19074.4	2	65	IMPELLER	EBV260A-12	1				
20	IGNITION MODULE	1E34F-7B.5	1	43	PIN 3x10	GB/7119	4	66	WASHER 8		1				
21	SCREW M4x20	GB/19074.4	2	44	CRANK CASE-FRONT HALF	1E34F-7-1	1	67	RUBBER	EBV260A-40	4				
22	CYLINDER	1E34F-7A-1	1	45	SCREW ST4.8x25		1	68	NUTE		1				
23	GASKET-CYLINDER	1E34F-9	1	46	FLY WHEEL	1E34F	1	69	VOLUTE CASE	EBV260A-3	1				

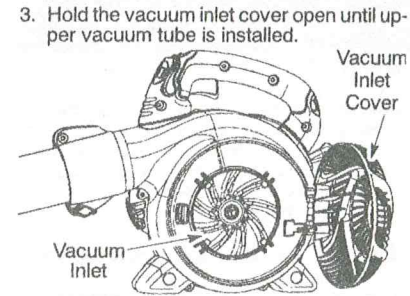

3. Hold the vacuum inlet cover open until upper vacuum tube is installed.

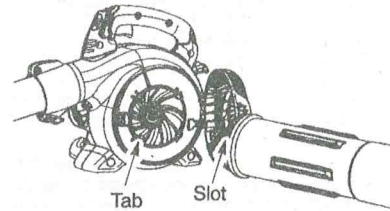

4. Align the tabs on the inside of the vacuum inlet with the slots on the upper vacuum tube.

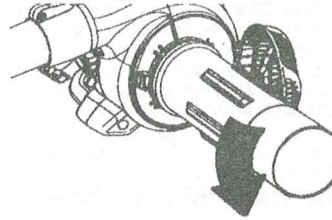

5. Push the upper vacuum tube into the vacuum inlet. Turn the tube counterclockwise until a click is felt to secure the tube to the blower unit.

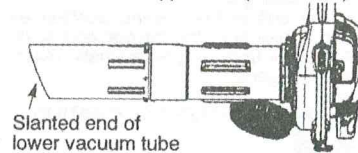

6. Align slanted end of lower vacuum tube as shown. Push lower vacuum tube into upper vacuum tube until the lower tube is securely seated in the upper tube (about 7 cm).

7. When vacuum tubes are fitted together, locate the label on the lower portion of the upper tube. Permanently assemble the two tubes together with the supplied screw.

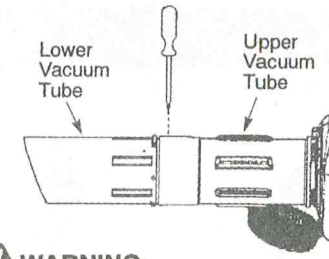

WARNING:

Before starting engine, both lower and upper vacuum tube must be installed.

HOW TO CONVERT UNIT FROM VACUUM USE TO BLOWER USE

1. Remove the elbow tube and vacuum bag by turning the knob counterclockwise to loosen the elbow tube.
2. Remove the vacuum tubes by turning the tubes clockwise.
3. Close the vacuum inlet cover and make sure it is latched closed.
4. Reinstall the blower tubes (see BLOWER TUBE ASSEMBLY).

SHOULDER STRAP ADJUSTMENT

1. Hold the unit as shown with the muffler side facing away from your body and clothes.
2. Pass the shoulder strap over your head and onto your right shoulder.
3. Extend your left arm toward the rear of the vacuum bag.
4. Adjust shoulder strap until the vacuum bag/shoulder strap seam lies between your thumb and index finger.
5. Make sure air flows freely from the elbow tube into bag. If bag is kinked, the unit will not operate properly.

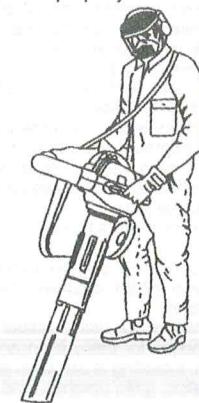

OPERATION

OPERATING POSITION

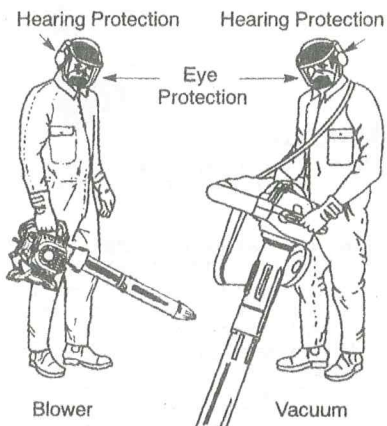

OPERATING TIPS

- While vacuuming or blowing debris, hold the unit with the muffer side facing away from your body and clothes (see OPERATING POSITION).
- To reduce the risk of hearing loss associated with sound level(s), hearing protection is required.
- To reduce the risk of injury associated with contacting rotating parts, stop the engine before installing or removing attachments. Do not operate without guard(s) in place.
- Operate power equipment only at reasonable hours—not early in the morning or late at night when people might be disturbed. Comply with times listed in local ordinances. Usual recommendations are 9:00 a.m. to 5:00 p.m., Monday through Saturday.
- To reduce noise levels, limit the number of pieces of equipment used at any one time.
- To reduce noise levels, operate power blowers at the lowest possible throttle speed to do the job.
- Use rakes and brooms to loosen debris before blowing.
- In dusty conditions, slightly dampen surfaces or use a mister attachment when water is available.
- Conserve water by using power blowers instead of hoses for many lawn and garden applications, including areas such as gutters, screens, patios, grills, porches, and gardens.
- Watch out for children, pets, open windows, or freshly washed cars. Blow debris away safely.
- Use the full blower nozzle extension so the air stream can work close to the ground.
- After using blowers and other equipment, CLEAN UP! Dispose of debris in trash receptacles.

BEFORE STARTING ENGINE

⚠ WARNING: Be sure to read the fuel information in the safety rules before you begin. If you do not understand the safety rules, do not attempt to fuel your unit. Contact an authorized service dealer.

FUELING ENGINE

⚠ WARNING: Remove fuel cap slowly when refueling.

This engine is certified to operate on unleaded petrol. Before operation, petrol must be mixed with a good quality 2-cycle air-cooled engine oil. We recommend JASO FB oil mixed at a ratio of 40:1 (2.5%). A 40:1 ratio is obtained by mixing 5 liters of unleaded petrol with 0.125 liter of oil. When mixing fuel, follow the instructions printed on the container. Always read and follow the safety rules before fueling your unit.

IMPORTANT

Experience indicates that alcohol blended fuels (called gasohol or using ethanol or methanol) can attract moisture which leads to separation and formation of acids during storage. Acidic gas can damage the fuel system of an engine while in storage. To avoid engine problems, empty the fuel system before storage for 30 days or longer. Drain the gas tank, start the engine and let it run until the fuel lines and carburetor are empty. Use fresh fuel next season. Never use engine or carburetor cleaner products in the fuel tank or permanent damage may occur.

HOW TO STOP YOUR ENGINE

- Release the throttle trigger.
- Push and hold the STOP switch in the STOP position until the engine stops.

BEFORE STARTING THE ENGINE

⚠ WARNING: You MUST make sure the tubes are secure before using the unit.

- Fuel engine. Move at least 3 meters away from the fueling site.
- Hold the unit in the starting position as shown. Make sure the blower end is directed away from people, animals, glass, and solid objects.

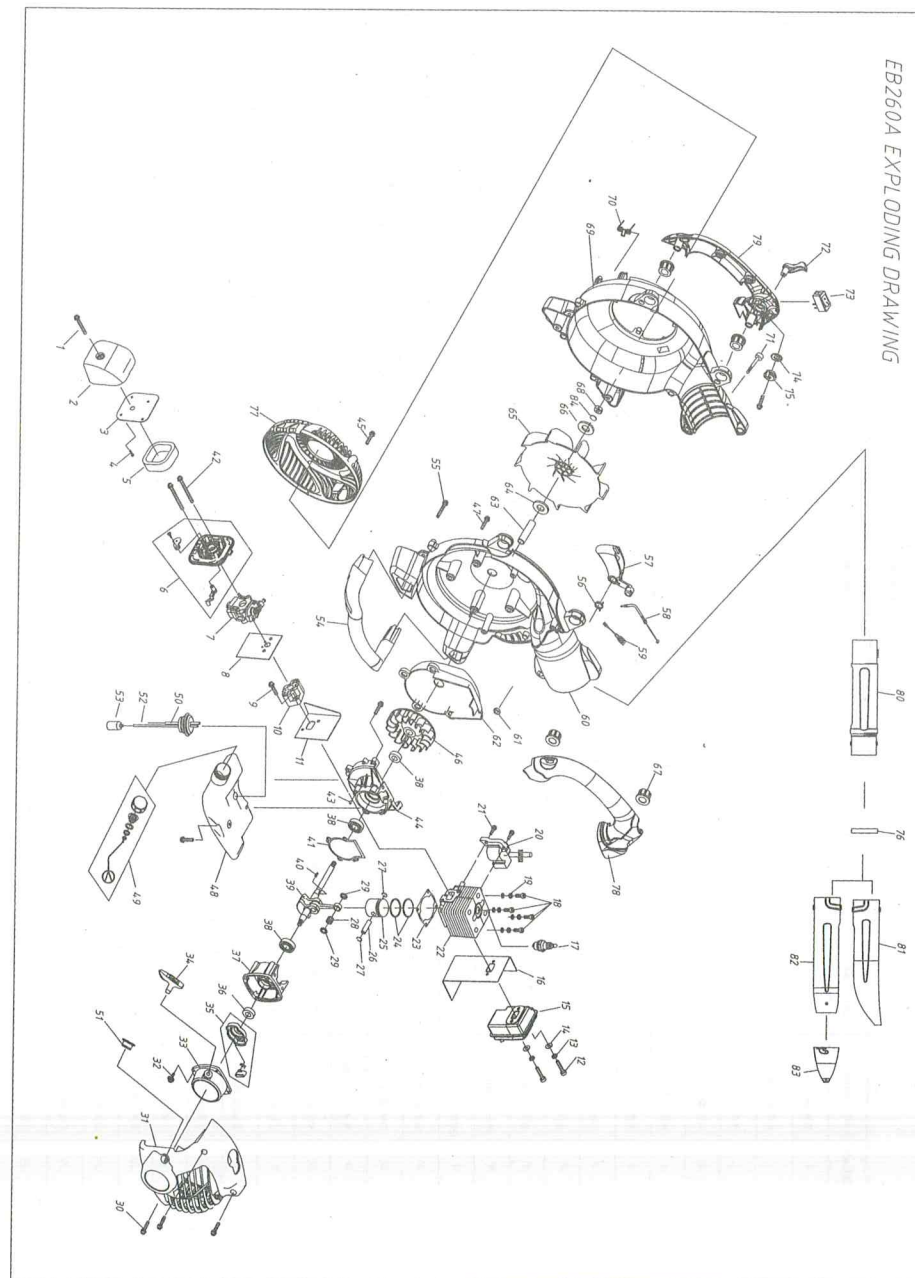
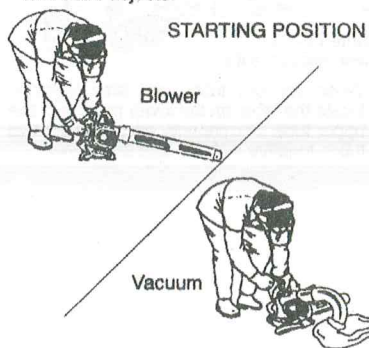

TROUBLESHOOTING TABLE

⚠ WARNING: Always stop unit and disconnect spark plug before performing any of the recommended remedies below other than remedies that require operation of the unit.

TROUBLE	CAUSE	REMEDY
Engine will not start.	1. Engine flooded. 2. Fuel tank empty. 3. Spark plug not firing. 4. Fuel not reaching carburetor. 5. Compression low.	1. See "Starting Instructions." 2. Fill tank with correct fuel mixture. 3. Install new spark plug. 4. Check for dirty fuel filter; replace. Check for kinked or split fuel line; repair or replace. 5. Contact an authorized service dealer.
Engine will not idle properly.	1. Fuel not reaching carburetor. 2. Carburetor requires adjustment. 3. Crankshaft seals worn. 4. Compression low.	1. Check for dirty fuel filter; replace. Check for kinked or split fuel line; repair or replace. 2. Contact an authorized service dealer. 3. Contact an authorized service dealer. 4. Contact an authorized service dealer.
Engine will not accelerate, lacks power, or dies under a load.	1. Air filter dirty. 2. Fuel not reaching carburetor. 3. Spark plug fouled. 4. Spark arresting screen clogged. 5. Carburetor requires adjustment. 6. Carbon build up. 7. Compression low.	1. Clean or replace air filter. 2. Check for dirty fuel filter; replace. Check for kinked or split fuel line; repair or replace. 3. Clean or replace spark plug; re-gap. 4. Replace screen. 5. Contact an authorized service dealer. 6. Contact an authorized service dealer. 7. Contact an authorized service dealer.
Engine smokes excessively.	1. Choke partially on. 2. Fuel mixture incorrect. 3. Air filter dirty. 4. Carburetor requires adjustment.	1. Adjust choke. 2. Empty fuel tank and refill with correct fuel mixture. 3. Clean or replace air filter. 4. Contact an authorized service dealer.
Engine runs hot.	1. Fuel mixture incorrect. 2. Spark plug incorrect. 3. Carburetor requires adjustment. 4. Carbon build up.	1. See "Fueling Your Unit." 2. Replace with correct spark plug. 3. Contact an authorized service dealer. 4. Contact an authorized service dealer.

TECHNICAL DATA

MODEL	EBV260A	EB260A
Engine	1E34F	
Type	2 stroke, air-cooled gasoline engine	
Displacement	25.4cc	
Maximum Engine Power	0.75kw/7500rpm	
Idle Speed ±200	2800rpm	
Noise	≤108 dB(A)	
Spark plug	L6 (RCJ6Y)	
Fuel mix ratio	30 : 1	
Fuel tank capacity	450ml	
Air velocity	≥41m/s	
Air volume	≥0.2m³/s	
Net weight (kg)	5.8	4.5
Gross weight (kg)	7.3	5.3

⚠ WARNING: When starting engine, hold the unit as illustrated. Do not set unit on any surface except a clean, hard area when starting engine or while engine is running. Debris such as gravel, sand, dust, grass, etc. could be picked up by the air intake and thrown out through the discharge opening, damaging the unit or property, or causing serious injury to bystanders or the operator.

STARTING A COLD ENGINE (or a warm engine after running out of fuel)

1. Move the throttle position lever to the idle position.

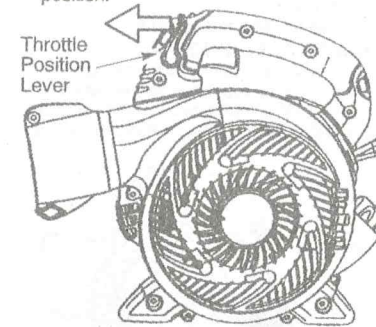

2. Slowly press the primer bulb 6 times.
3. Move the start lever to the START position.

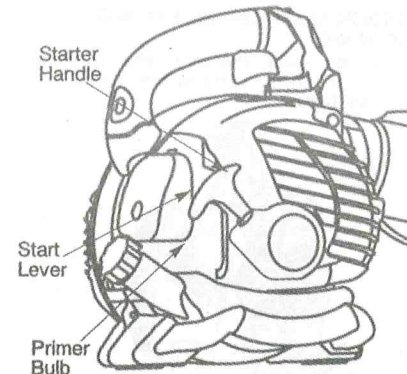

4. Pull starter rope handle sharply 5 times (no more than 3 times above 32°C/90°F). If engine starts and runs prior to 5 pulls, allow engine to run for 5 seconds; then, fully squeeze the throttle trigger to disengage the starting system (start lever returns to RUN position). Steps 5 and 6 are not necessary.
5. Fully squeeze the throttle trigger to disengage the starting system (start lever returns to RUN position).
6. Pull starter rope handle sharply while squeezing throttle trigger until engine starts and runs.

STARTING A WARM ENGINE

1. Squeeze and hold the throttle trigger.
2. Pull starter rope handle sharply while squeezing throttle trigger until engine starts and runs.

NOTE: Normally, the warm starting procedure can be used within 5-10 minutes after the unit is turned off. If the unit sits for more than 10 minutes without being used, it will be necessary to start the unit by following the steps under STARTING A COLD ENGINE or following the starting instruction steps shown on the unit.

STARTING A FLOODED ENGINE

Flooded engines can be started by moving the start lever to the RUN position and fully squeezing the throttle trigger. Pull the starter handle repeatedly while squeezing throttle trigger until engine starts and runs. This could require pulling the starter handle many times, depending on how badly the unit is flooded. If the unit still doesn't start, refer to the TROUBLESHOOTING TABLE.

MAINTENANCE

WARNING: Avoid touching muffler unless engine and muffler are cold. A hot muffler can cause serious burns.

WARNING: Disconnect the spark plug before performing maintenance except for carburetor adjustments.

CHECK FOR LOOSE FASTENERS AND PARTS

- Muffler
- Spark Plug Boot
- Air Filter
- Housing Screws

CHECK FOR DAMAGED OR WORN PARTS

Contact an authorized service dealer for replacement of damaged or worn parts.

- Fuel Tank. Discontinue use of unit if fuel tank is damaged or leaks.
- Vacuum Bag - Discontinue use of vacuum bag if it is torn or damaged.

INSPECT AND CLEAN UNIT & LABELS

- After each use, inspect complete unit for loose or damaged parts. Clean the unit and decals using a damp cloth with a mild detergent.
- Wipe off unit with a clean dry cloth.

CLEAN AIR FILTER

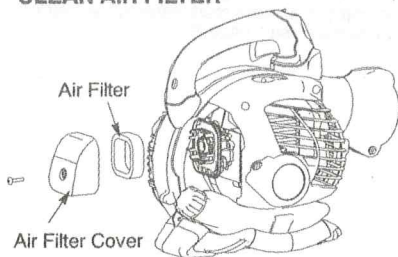

A dirty air filter decreases engine performance and increases fuel consumption and harmful emissions. Always clean after every 5 hours of operation or yearly, whichever comes first.

1. Clean the cover and the area around it to keep debris from falling into the carburetor chamber when the cover is removed.

NOTE: Move choke lever to RUN position before opening air filter cover.

2. Remove parts as illustrated.

NOTE: Do not clean filter in gasoline or other flammable solvent. Doing so can create a fire hazard or produce harmful evaporative emissions.

3. Wash the filter in soap and water.
4. Allow filter to dry.
5. Apply a few drops of oil to the filter; squeeze filter to distribute oil.
6. Replace parts.

REPLACE SPARK PLUG

Replace spark plug each year to ensure the engine starts easier and runs better. Set spark plug gap at 0.6 mm. Ignition timing is fixed, nonadjustable.

1. Twist, then pull off spark plug boot.
2. Remove spark plug from cylinder and discard.
3. Replace with Champion RCJ-8Y spark plug and tighten securely with a 19 mm socket wrench.
4. Reinstall the spark plug boot.

REPLACE FUEL FILTER

To replace fuel filter, drain unit by running it dry of fuel, then remove fuel cap/retainer assembly from tank. Pull filter from tank and remove it from fuel line. Install new fuel filter on fuel line; reinstall parts.

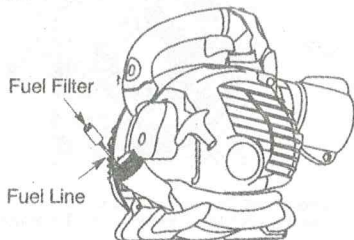

CHECK MUFFLER MOUNTING SCREWS

Once each year, ensure muffler mounting screws are secure and tightened properly to prevent damage.

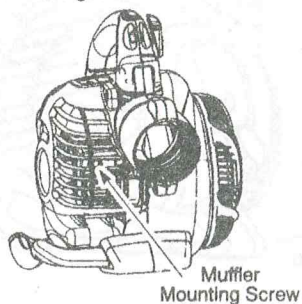

CARBURETOR ADJUSTMENTS

The carburetor has been carefully set at the factory. Adjustments may be necessary if you notice any of the following conditions:

- Engine will not idle when the throttle is released.

Idle Speed Adjustment

Allow engine to idle. Adjust speed until engine runs without stalling (idle speed too slow).

- Turn idle speed screw clockwise to increase engine speed if engine stalls or dies.

- Turn idle speed screw counterclockwise to decrease engine speed.
- Idle Speed Screw

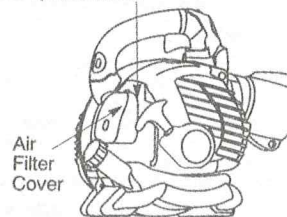

STORAGE

WARNING: Prepare unit for storage at end of season or if it will not be used for 30 days or more.

- Allow engine to cool, and secure the unit before storing or transporting.
- Store unit and fuel in a well ventilated area where fuel vapors cannot reach sparks or open flames from water heaters, electric motors or switches, furnaces, etc.
- Store unit with all guards in place. Position unit so that any sharp object cannot accidentally cause injury.
- Store unit and fuel well out of the reach of children.

EXTERNAL SURFACES

- If your unit is to be stored for a period of time, clean it thoroughly before storage. Store in a clean dry area.
- Lightly oil external metal surfaces.

If you require further assistance or are unsure about performing this procedure, contact an authorized service dealer.

INTERNAL ENGINE

- Remove spark plug and pour 1 teaspoon of 2-cycle engine oil (air cooled) through the spark plug opening. Slowly pull the starter rope 8 to 10 times to distribute oil.
- Replace spark plug with new one of recommended type and heat range.
- Clean air filter.
- Check entire unit for loose screws, nuts, and bolts. Replace any damaged, broken, or worn parts.
- Start each season using only fresh fuel having the proper gasoline to oil ratio.

OTHER

- Do not store gasoline from one season to another.
- Replace your gasoline can if it starts to rust.